

Datasheet - AZ 15/16-B2

Safety switch with separate actuator / AZ 16 / Actuator AZ 16



Preferred typ

• For very small actuating radii in line with the plane of the actuator



(Minor differences between the printed image and the original product may exist!)

Ordering details

Product type description	AZ 15/16-B2
Article number	101095558
EAN code	4030661268118
eCl@ss	27-27-92-16

Global Properties

Product name	Beweglicher Betätiger AZ 15/16-B2
Weight	18 g

Mechanical data

Design of actuators	angled, flexible
Minimum actuating radius	45 mm

notice

Actuating radius adjustable, minimum 45 mm, using an hexagonal key wrench 2,5 mm (a) A/F
The axis of the hinge should be 11 mm above the top edge of the safety switch and in the same plane

Documents

Operating instructions and Declaration of conformity (fi) 101 kB, 02.07.2015

Code: mrl_az15-16-betaetiger_fi

Operating instructions and Declaration of conformity (es) 115 kB, 12.02.2014

Code: mrl_az15-16-betaetiger_es

Operating instructions and Declaration of conformity (it) 114 kB, 10.02.2014

Code: mrl_az15-16-betaetiger_it

Operating instructions and Declaration of conformity (de) 296 kB, 30.01.2014

Code: mrl_az15-16-betaetiger_de

Operating instructions and Declaration of conformity (cn) 137 kB, 30.06.2015

Code: mrl_az15-16-betaetiger_cn

Operating instructions and Declaration of conformity (nl) 114 kB, 11.03.2014

Code: mrl_az15-16-betaetiger_nl

Operating instructions and Declaration of conformity (pt) 115 kB, 23.05.2014

Code: mrl_az15-16-betaetiger_pt

Operating instructions and Declaration of conformity (jp) 165 kB, 11.08.2014

Code: mrl_az15-16-betaetiger_jp

Operating instructions and Declaration of conformity (en) 114 kB, 24.02.2014

Code: mrl_az15-16-betaetiger_en

Operating instructions and Declaration of conformity (pl) 155 kB, 11.03.2014

Code: mrl_az15-16-betaetiger_pl

Operating instructions and Declaration of conformity (fr) 114 kB, 14.04.2014

Code: mrl_az15-16-betaetiger_fr

Operating instructions and Declaration of conformity (sv) 113 kB, 17.06.2015

Code: mrl_az15-16-betaetiger_sv

Images

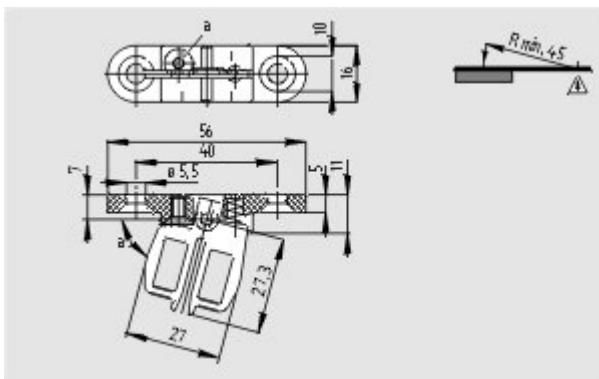

Dimensional drawing (actuator)

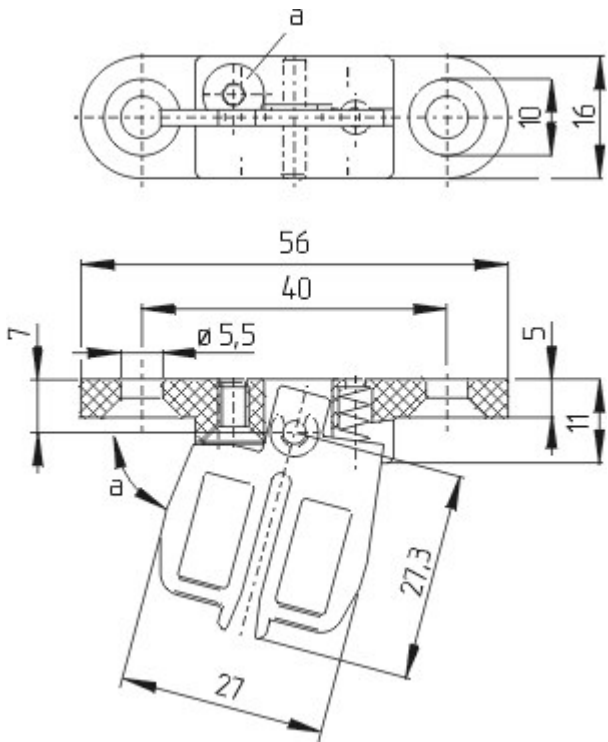

Dimensional drawing (miscellaneous)

K.A. Schmersal GmbH & Co. KG, Möddinghofe 30, D-42279 Wuppertal

The data and values have been checked thoroughly. Technical modifications and errors excepted.

Generiert am 30.10.2017 - 12:46:39h Kasbase 3.2.7.F.64I