

Standards:

IEC51, IEC61010-1, VDE410, BS89, UL94, EN60051, DIN43780

Cases:

All cases at least dust and splash water-proof.
All cases are made of strengthened self-extinguishing PPO
With a high hit-resistance and a maximum electric isolation

Accuracy class:

AC, DC Voltmeters and Ammeters comply with the accuracy class 1.5.

- The power meters comply with accuracy class 1.5.
- The frequency meters comply with accuracy class 1.0.
- The maximum-demand meters with accuracy class 3.0.
- The power factor meters and synchroscope meter comply with accuracy class 2.5.

Insulation test:

The insulation test is carried out at a voltage of 2KV, 50Hz 1 min and applies for instruments with the full scale deflection up to 650V. Other standards comply with IEC61010-1.

Temperature influence:

All instruments operate trouble-free at room temperature ranging from -25°C to + 40°C.

The Max. Voltage to earth Voltmeter-The upper range voltage (full scale deflection)

















Ammeter-The Voltage of the main power supply.

The meter used shall be keep cleaning. The user shall be made aware that, if the meter is used in a manner not specified by the manufacturer, the protection provided by the meter may be impaired.

Mounting angle:

The instruments are calibrated for vertical mounting, unless other positions such as horizontal or inclined at any specified angle to the horizon. can be provided upon request (in this case, specify angle of inclination, please)
The accuracy class refers to the specified mounting angle only.

Singals for Identification of the Instruments Tech Characteristics:

	Electronic device in a measure circuit
	Rectifier (instrument with AC input)
	Shunt
	Additional resistor
	Positive terminal
	Negative terminal
1.0 1.5 2.5	Class Index
	DC
	AC
	DC & AC
	Testing voltage higher than 500V
	Vertical mounting
	Inclined mounting (for example 50°)
	Moving coil for DC instruments
	Moving Iron for AC instruments
	Bimetal instrument
	Vibrating reeds instruments

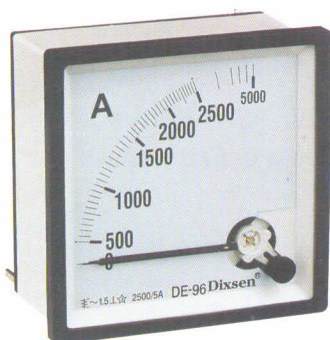

Moving Iron AC Ammeter:

Model: DE-96, DE-72, DE-48

Class: 1.5

Specs: 0.1A, 0.5A, 1A, 1.5A, 3A, 5A, 7.5A, 10A, 15A, 20A, 25A, 30A, 50A, 75-105A (use Ext. CT 5A)

Note: For 60/75/100A direct meter, the class is 2.5.

Advantage: The scale can be easily changed without opening the front frame so that the class will not be influenced.

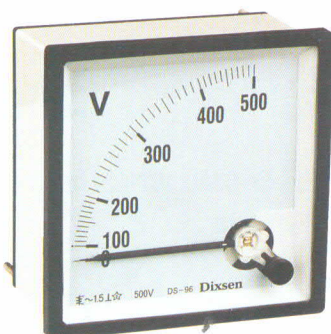

AC Voltmeter:

Model: DE-96, DE-72, DE-48

Class: 1.5

Specs: 30V, 50V, 75V, 100V, 120V, 150V, 250V, 300V, 450V, 600V (For 450-380KV, should be used with potential transformer whose secondary voltage 100V).

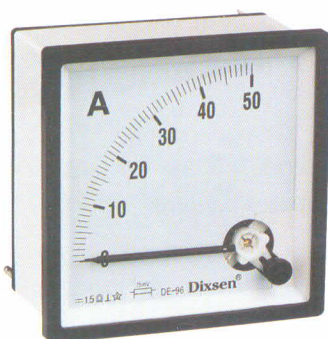

Moving Coil AC Ammeter:

Model: DE-96, DE-72, DE-48

Class: 1.5

Specs: 25uA, 30uA, 50uA, 1mA, 2mA, 5mA, 10mA, 20mA, 30mA, 50mA, 75mA, 100mA, 150mA, 200mA, 250mA, 300mA, 500mA, 1A, 3A, 5A, 7.5A, 10A, 20A, 30A, 50A, 75-105A (used with Shunt)

Note: For 60/75/100A direct meters, the Class should be 2.5.

Advantage: The scale can be easily changed without opening the front frame so that the class will not be influenced.

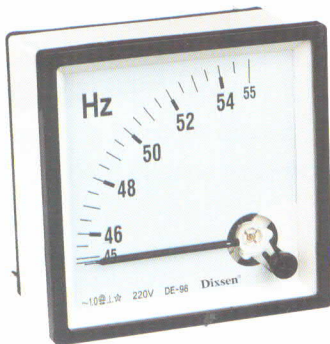
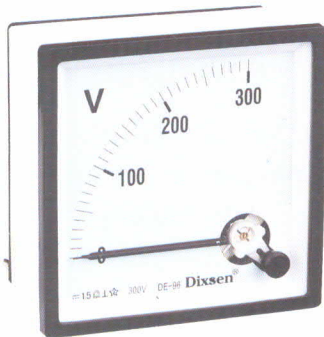

DC Voltmeter:

Model: DE-96, DE-72, DE-48

Class: 1.5

Specs: 3V, 5V, 7.5V, 10V, 15V, 20V, 30V, 50V, 75V, 100V, 120V, 150V, 200V, 250V, 300V, 400V, 450V, 600V

Note: Over 600V should be used with Ext. Resistor.

(Rated Current 5mA).

Frequency Meter

Pointer Type:

Model: DE-96, DE-72, DE-48

Class: 1.0

Volt: 50V, 100V, 220V, 380V

Freq: 44-55Hz, 45-65Hz, 55-65Hz, 47-53Hz, 57-63Hz, 44-56Hz, 54-66Hz, 450-550Hz, 550-650Hz

Power Factor Meter:

For 3 phases circuits, balanced load 45-65Hz and for 1 phase AC 50Hz.

Model: DE-96, DE-72

Class: 2.5

Voltage: 100V, 380V, 440V

Frequency: 50Hz, 60Hz

Scale graduation: 0.5cap-1-0.5ind, 0.3cap-1-0.7ind, 0.4cap-1-0.4ind, 0.7-cap-1-0.3ind

Orders to be noted:

Type of Current: 1P, 3P 3W circuits, balanced load.

Rated Volt: The voltage is line voltage (between two wire).

Operating Current: If used with CT, the secondary current 5A or 1A is standard.

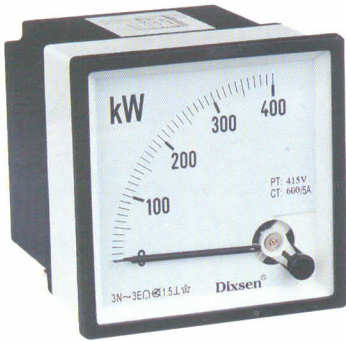

Power Meter:

Wattmeters or Varmeters with build-in converter for 1 phase 3P 3W, 3P 4W.

Model: DE-96, DE-72

Class: 1.5

Voltage: 50V, 100V, 220V, 240V, 220/380V, 240/415V

Current: 5A

These meters are used with potential secondary voltage 100V voltage transformer or secondary current 5A CT. Wattmeters with built-in converter for 3P 3W, 3P 4W and single phase.

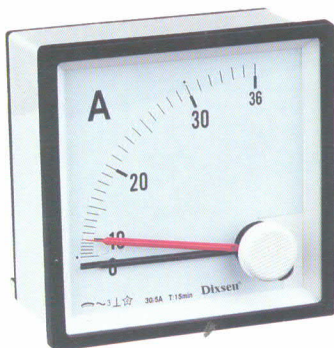

Maximum Demand Meter

Single structure:

For measuring mean maximum current values

Model: DE-96, DE-72

Class: 3.0

Specs: 8min 5A 15min 5A

8min 1A 15min 1A



Double Structure:

For measuring mean maximum current values and instantaneous values for combined with moving iron movement meters.

Model: DE-96

Class: Bimetal Movement 3.0

Moving Iron 1.5

Specs.: 8min 5A 15min 5A

8min 1A 15min 1A

These meters can measure the max. mean load in 8 or 15 minutes, by the red pointer indicated. And this red pointer can be resetted to zero position.



Flush mounting with fixture:

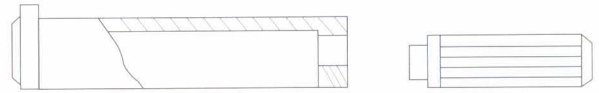

Fixture

Nut

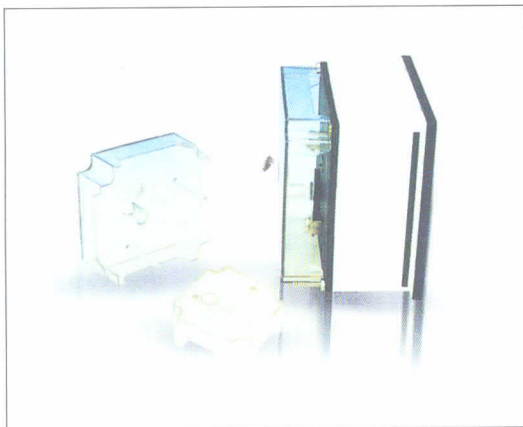
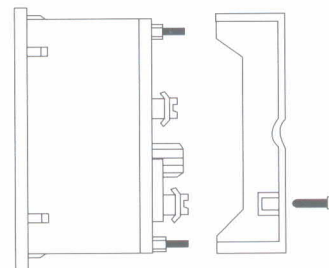
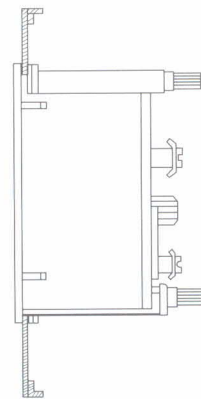

Outline and Mounting Dimensions:

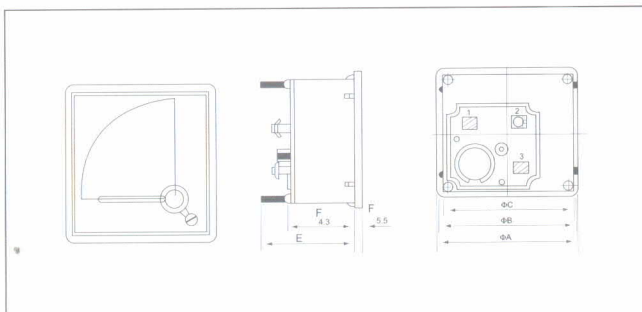

Model	Unit	A	B	C	D	E	F
DE-96	mm	96	91	90	5.5	65	43
	In	3.78	3.58	3.54	0.22	2.56	1.69
DE-72	mm	72	67	66	5.5	65	43
	In	2.83	2.64	2.60	0.22	2.56	1.69
DE-48	mm	48	43	42	5.5	65	43
	In	1.89	1.69	1.69	0.22	2.56	1.69



DE-50



DE-60

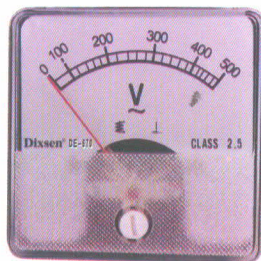

DE-670

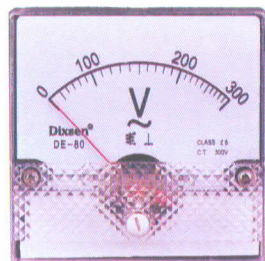

DE-80

Technical data:

Name	Specifications			Remarks
DC Ammeter	30-1000uA	1-1000mA 1K -10KA	1-50A	Direct connection With Ext. SHUNT
DC Voltmeter	40-1000mV	1-1000V 1K -10KA		Direct connection With Ext. Resistor
AC Ammeter	1-1000mA 5-1000A	1-50A 1K -10KA		Direct connection With Ext. CT
AC Voltmeter	40-1000mA	1-1000V 1K -380KV		Direct connection With Ext. CT
Frequency Meter	50-380V 44-55Hz	45-65Hz	55-65Hz	

Dimensions(mm):

Model	A	B	C	D	E	F	G	H	M	For Hole
DE-50	50	52	23.5	13.5	4.4	12.5	45	19	3	46
DE-60	60	60	24	11	9.5	11	52	24	3	53
DE-670	60	70	23	10	11	12	52	24	3	53
DE-80	81	81	22	12	18.5	13.5	63.5	32.5	3	65

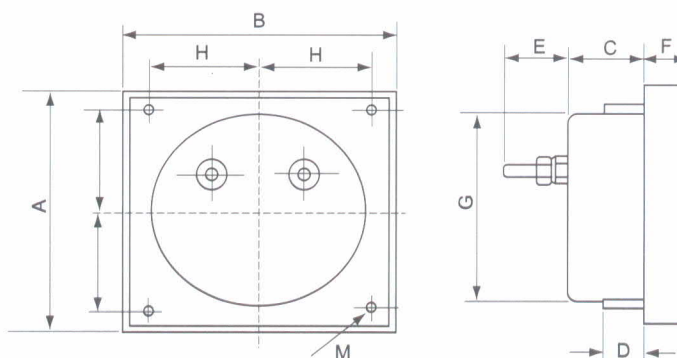

Struction: Moving Coil, Moving Iron and Rectifier.
Class: 2.0, 2.5